

SCHATTELLO mountable high table, mounting instructions and manual

Thank you for purchasing our mountable high table.

The following instructions include all information necessary for the assembly of this MAY mountable high table. To avoid any misunderstanding, we advise you to read these instructions carefully and then keep them for later reference.



Caution

Non- observation of mounting instructions can result in personal injuries or damage to property.

Please note that if these instructions are not observed, the manufacturer cannot assume any liability or guarantee.

- Always follow the safety regulations.
- Should you not understand any part of these mounting instructions, please contact your MAY dealer.

Scope of delivery

The mountable high table for SCHATTELLO parasols consists of following parts:

- 2x half shells, anodised aluminium, including 2 rubber tapes and 2 cylinder head screws M8x30mm
- 2x table plates, HPL material, including bracing and fixture
- 2x locking pins

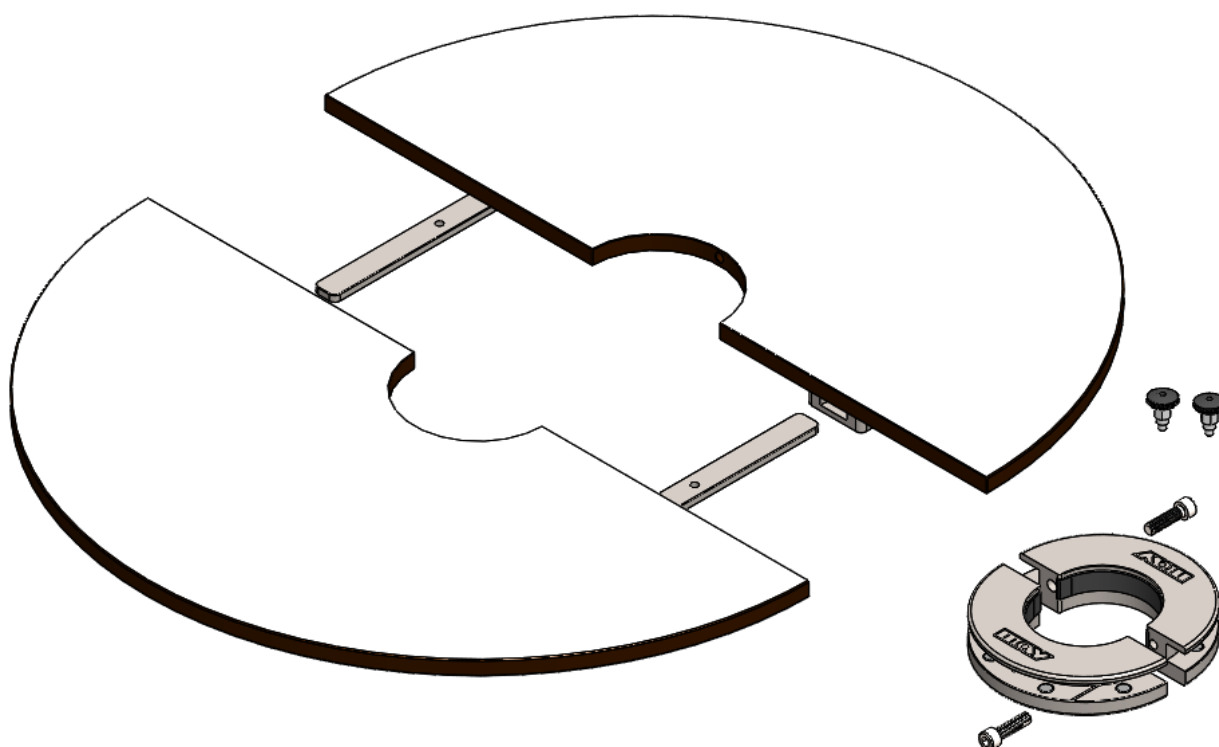

Mounting the aluminium half shells

This step has only to be done once. The "half shells" remain at the parasol permanently, even if the table plates are disassembled and the parasol is closed. Rounded edges and chamfers make sure to avoid chafe marks at the canopy, in case of wind, when the parasol is closed. This applies only if the parasol has been closed properly as described in the operating manual, chapter „Closing the parasol“.

1. Open the parasol completely.
2. Attach the two half shells at the desired table height at the centre pole. Regular height for a high table is approximately 115 cm, for a regular table approximately 75 cm. Use the two cylinder screws to fix the two half shells. Use a hexagon key size 6, torque 18 Nm. Tighten the screws, alternately and in small increments, to make sure the gap is equal on both sides.

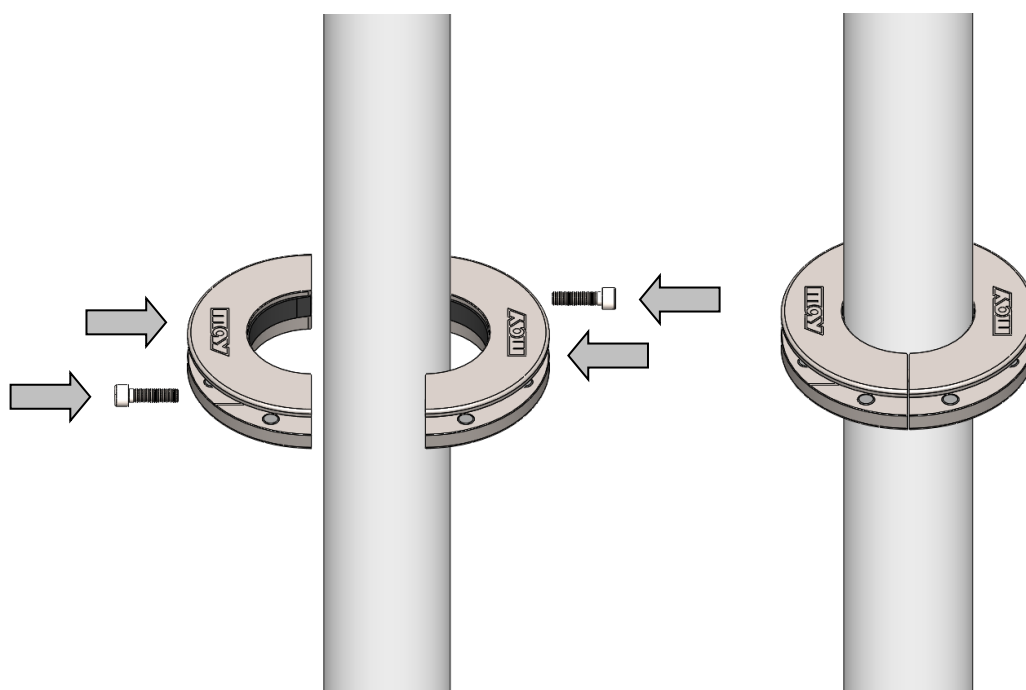

Mounting the HPL table plates

1. Screw the locking pins into the threads of the fixture and lock them with a flat wrench size 10.



2. Open the locking pins by a 90° turn.

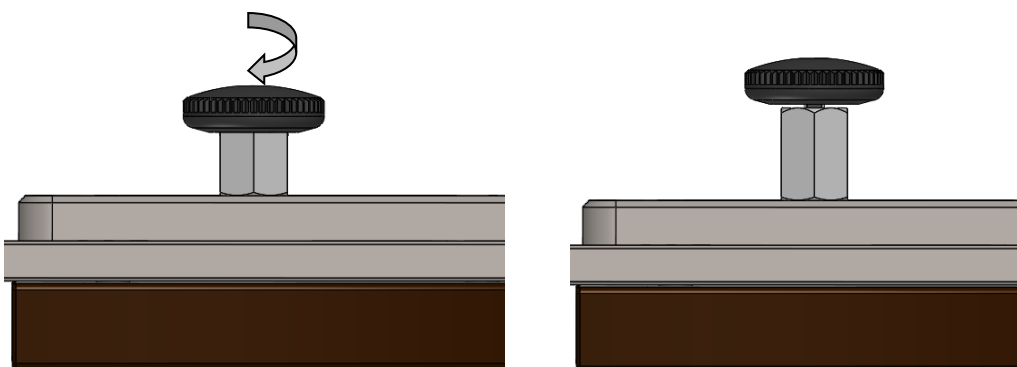

3. Turn the 8 adjustable screws until they no longer stick out, see picture below. Use a hexagon key size 6.

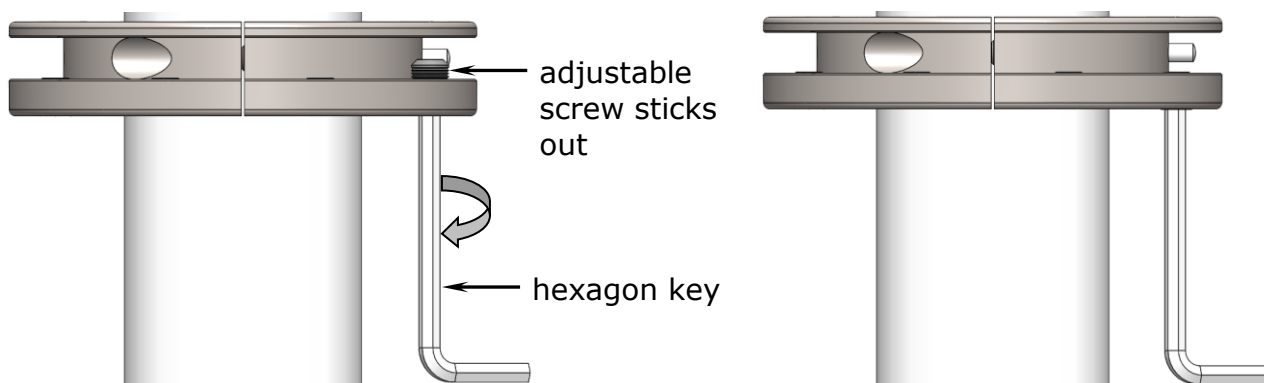

- Slide the first table plate into one half shell, make sure the centring bolt fits into the centring hole and the edges of the half shell and table plate are parallel.

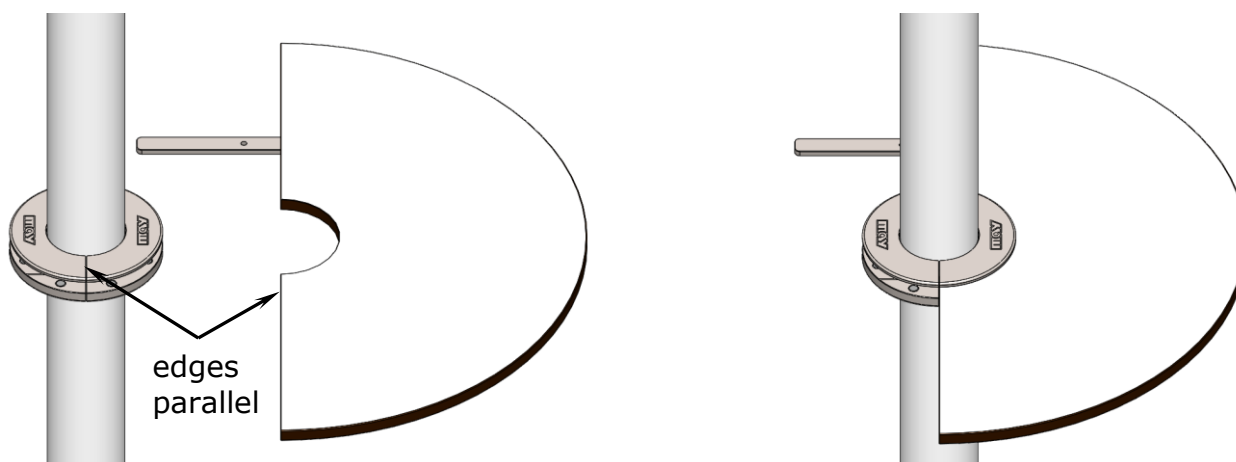

- Slide the second table plate into the first one, see picture.

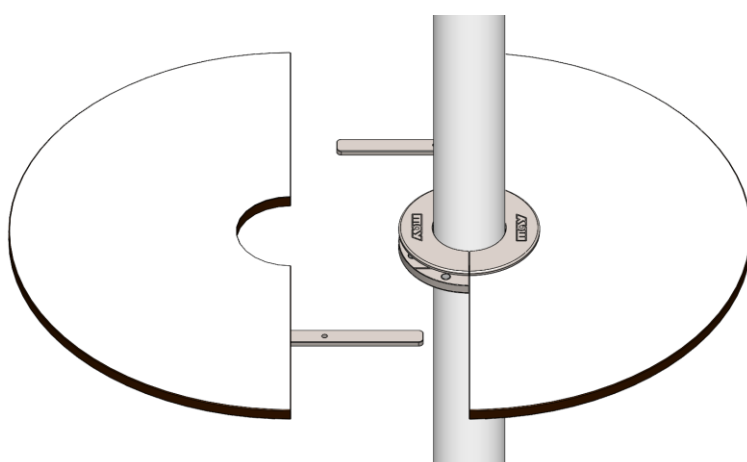

- Secure the two table plates in closed position. Turn the two locking pins until they lock (see picture of step 2).

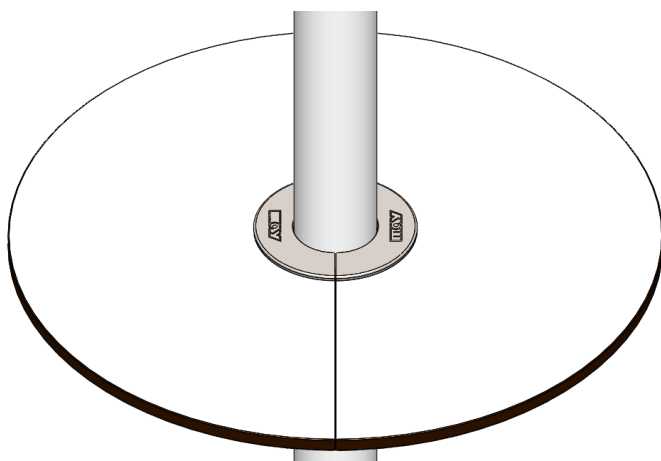

7. The table plates may be mounted and demounted daily. This way you can store them securely to avoid theft or damages through vandalism. In case of regular demounting, leave the 8 adjustable screws in a position they don't fix the table plates (see picture of step 3).
8. If the table plates are installed permanently, tighten the 8 adjustable screws with 3 Nm. This reduces the clearance and so the table plates won't wobble.



Caution

High table can damage the canopy.

Depending on the mounting height of the table, the parasol roof and/or the aluminium spokes may rest against the edges of the table, when the parasol is closed. The canopy may get caught in between which may cause chafe marks or abrasions. No guarantee or liability.

- If possible, mount the table below the longest spoke. This height depends on the size of the parasol, therefore we cannot indicate a general height recommendation for all parasols.
- If the table is mounted above the spoke, the table plates have to be removed before closing the parasol.

